

THIS COPY IS PROVIDED ON A RESTRICTED BASIS AND IS NOT TO BE USED IN ANY WAY DETRIMENTAL TO THE INTERESTS OF PANDUIT CORP.

PART#	DESCRIPTION	WEIGHT*
CJSK688TG**	8 POSITION, 8 WIRE SHIELDED MODULE WITH INTEGRAL SHIELD. TERMINATION CAP IS COLOR CODED FOR T568A AND T568B WIRING SCHEMES.	3.314 LB/100 PCS (1503g/100 PCS)

\*WEIGHT IS APPROXIMATE  
 \*\* = JACK COLOR/KEY SUFFIX  
 (SEE SHEET 2)

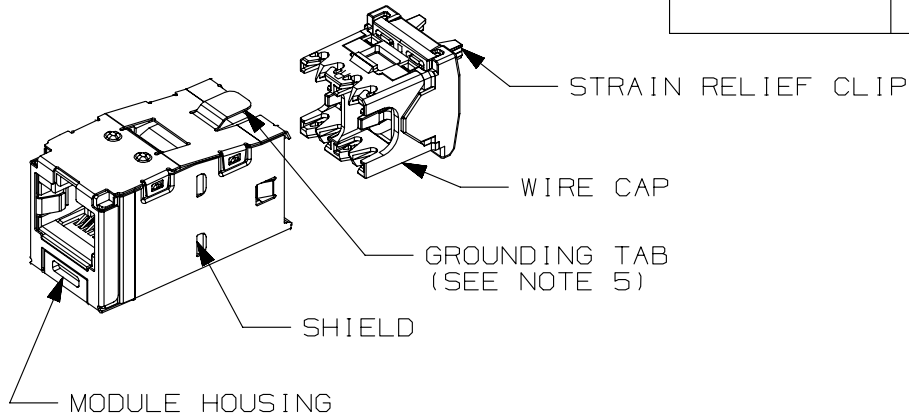

- NOTES:
1. WHITE WIRE CAP DESIGNATES CATEGORY 6 PERFORMANCE.
  2. MATERIAL:  
 MODULE HOUSING-ABS  
 NOMINAL WALL THICKNESS .078(2.0).  
 WIRE CAP-PC/ZINC
  3. ALL MINI-COM TX6 PLUS 8 POSITION, 8 WIRE, KEYED JACK MODULES ARE NOT UNIVERSAL IN DESIGN. EACH MODULE ACCEPTS ONLY ONE SPECIFIC KEYED PLUG THAT MATCHES THE JACK KEYED CONFIGURATION.
  4. DIMENSIONS IN PARENTHESES ARE IN METRIC.
  5. .187 x .010" GROUNDING TAB PROVIDED AS OPTIONAL CONDUCTIVE PATH FOR GROUNDING.

KEYED FEATURE  
 (SEE SHEET 2)

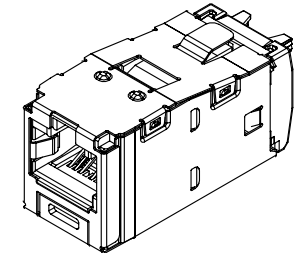
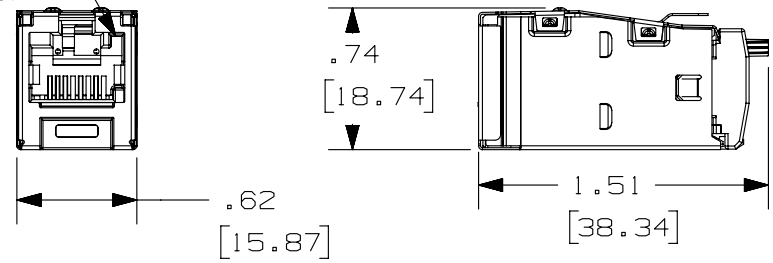

ACTUAL SIZE

PART NUMBER		CJSK688TG**	
TITLE			
MINI-COM TX6 PLUS SHIELDED KEYED JACK MODULE			
CUSTOMER DRAWING			
ITEM REVISION NAME		M03011EI/02	
DATASET FILE NAME		M03011EI_DC58/02A	
UNLESS OTHERWISE SPECIFIED, DIMENSIONAL TOLERANCES ARE: IN (mm)		MATERIAL:	
.x ± .xxx ± .010 (.3)		SEE NOTE 2	
.xx ± .03 (.8) ANGLES ±		DRAWING NUMBER:	
THIRD ANGLE PROJECTION		03011-58	
DRAWN BY	DATE	CHK	SCALE
MDJR	10-22-08	BMBA	FULL
SHT 1 OF 2			SIZE
			A

REV	DATE	BY	CHK	APR	DESCRIPTION	ECN
3	5-30-14	MDJR	REFR	EJH	A. UPDATED TITLE BLOCKS. REMOVED PREVIOUS REVISIONS FOR CLARITY.	03011-58

D101000DA/14

THIS COPY IS PROVIDED ON A RESTRICTED BASIS AND IS NOT TO BE USED IN ANY WAY DETRIMENTAL TO THE INTERESTS OF PANDUIT CORP.

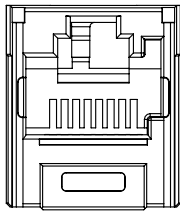
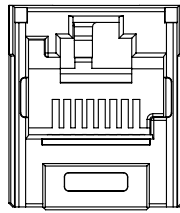
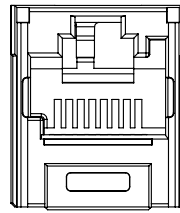
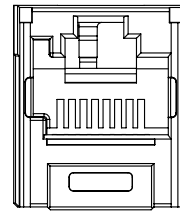
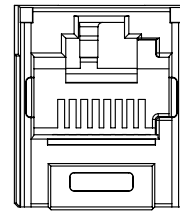
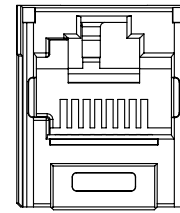
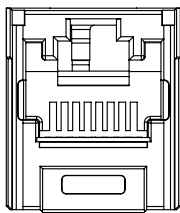
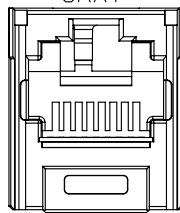
SHIELDED JACK COLOR/KEY CODE AND PART NUMBER					
A - BLACK	B - RED	C - GREEN	D - YELLOW	E - ORANGE	F - BLUE
					
CJSK688TGBL	CJSK688TGRD	CJSK688TGGR	CJSK688TGYL	CJSK688TGOR	CJSK688TGBU
G - VIOLET	H - INTERNATIONAL GRAY				
					
CJSK688TGVL	CJSK688TGIG				

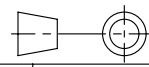
PART NUMBER		CJSK688TG**	
TITLE			
MINI-COM TX6 PLUS SHIELDED KEYED JACK MODULE			
CUSTOMER DRAWING			
ITEM REVISION NAME		M03011E1/02	
DATASET FILE NAME		M03011E1_DC58/02A	
UNLESS OTHERWISE SPECIFIED, DIMENSIONAL TOLERANCES ARE: IN (mm)		<b>PANDUIT</b>	
.x ± .xxx ± .010 (.3)			
.xx ± .03 (.8)		MATERIAL:  SEE NOTE 2 ON SHEET 1	
		DRAWING NUMBER: 03011-58	
		THIRD ANGLE PROJECTION	
DRAWN BY	DATE	CHK	SCALE
MDJR	10-22-08	BMBA	FULL
REV		SHT 2 OF 2	
DATE		SIZE	
		A	

REV	DATE	BY	CHK	APR	DESCRIPTION	ECN
3	5-30-14	MDJR	REFR	EJH	SEE SHEET 1 OF 2 FOR CHANGES	03011-58

D10100DA/14